

# MAG300

## MAGNETOSTRICTIVE

Measuring length absolute up to 3 m linear position transducer

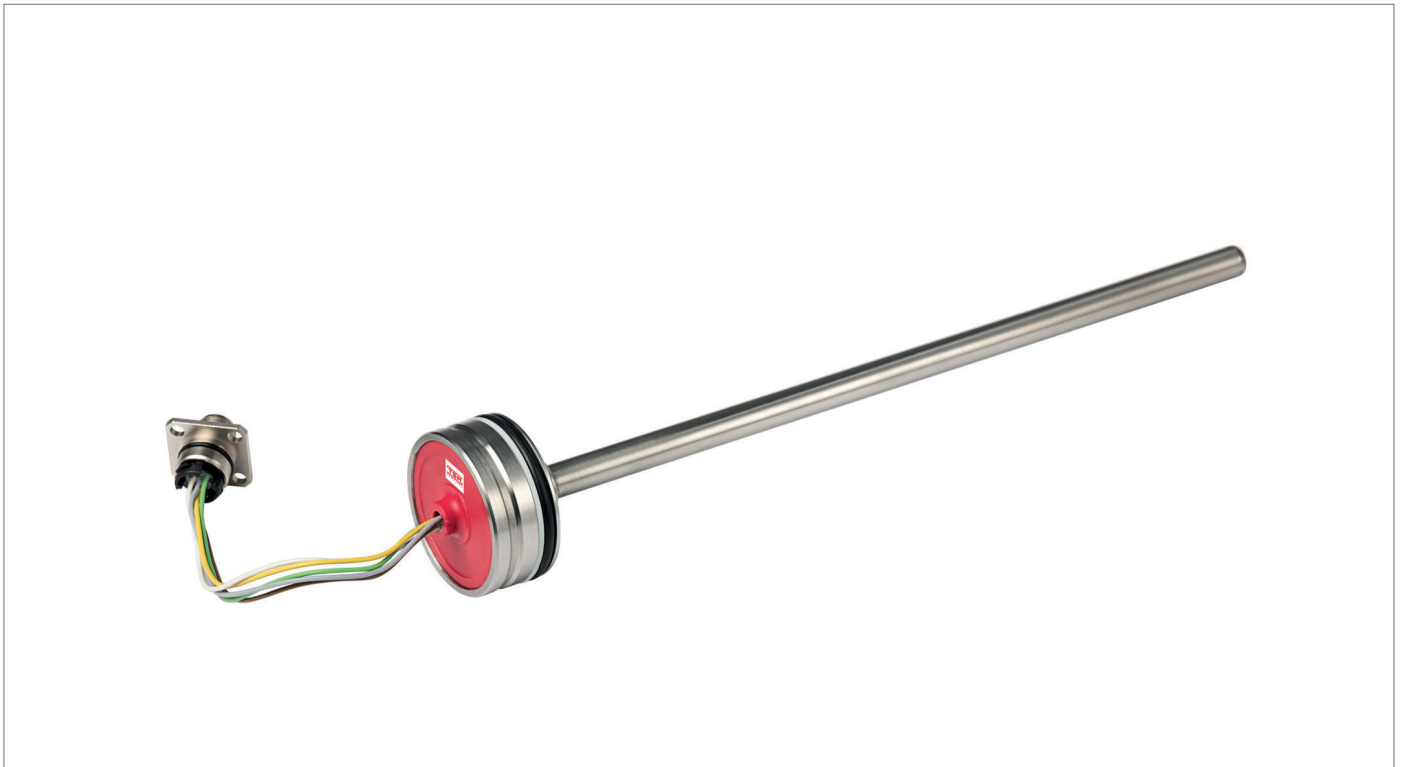

DATASHEET - Rev.3 - 18012018



### CHARACTERISTICS

Measuring range from 100 to 3000mm
For integration in pneumatic and hydraulic cylinders
High Resistance to shock and vibration
Plug-in flange
Absolute output
Working pressures up to 350bar
Customizable cursor



### ADVANTAGES

Absolute Contactless linear position measurement
High Resolution, High Linearity
Unlimited mechanical life
Designed for Welded and Tie-rod Cylinder Applications
Rod, nipple and flange AISI 316
Simple integration in cylinders with M12 plug-system
Position, speed and acceleration measured values



High protection level



Shock/vibration resistant



Redundancy output

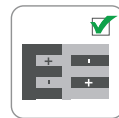

Reverse polarity protection

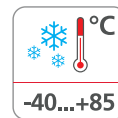

Wide range temperature



Functional safety



CANopen output



Directive 2011/65/EU



EU conformity

# MAG300

## MAGNETOSTRICTIVE

Measuring length absolute up to 3 m linear position transducer



### PRODUCT DESCRIPTION

MAG300 is a magnetostrictive position transducer with flanged connection that installs completely inside oil-pressure cylinders. Its unique design, plus a wide range of cursor configurations, ensures easy installation and total compatibility with cylinder manufacturer specifications.

Working temperature from -40 to +85°C, working pressures up to 350 bar, high resistance to vibration and shock give the sensor the indispensable strength needed for heavy-duty use.

High performance in terms of transduction of measurement defined as linearity, hysteresis and repeatability.

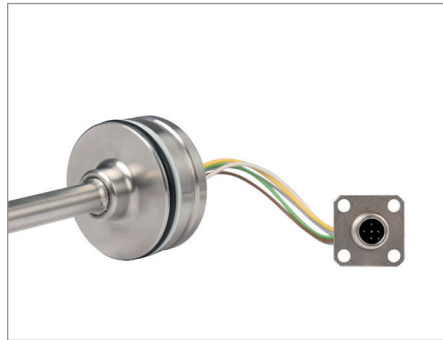
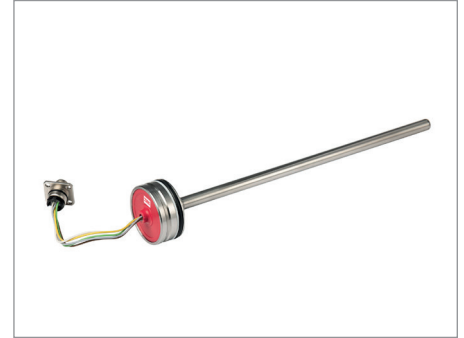

### PRODUCT CODE

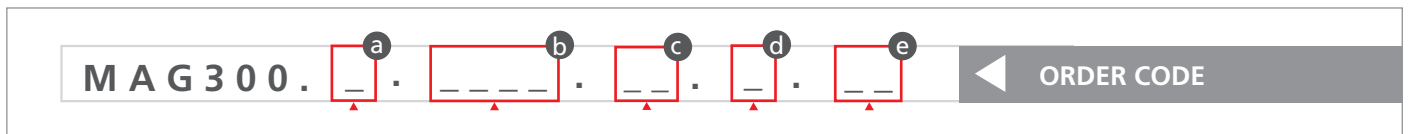

<b>a</b>	Power supply
<b>2</b>	← = 9 ... 30 VDC

<b>c</b>	Sensor Output
<b>6</b>	← = CANopen redundant
<b>28</b>	← = CANopen SIL2-Pld

<b>e</b>	Cursor
<b>X</b>	← = none
<b>0</b>	← = Custom cursor
<b>1</b>	← = Standard cursor

<b>b</b>	Measuring length
<b>XXXX</b>	← = mm (steps of 0100 mm)

<b>d</b>	Type of connection
<b>21A</b>	← = Plug system M12, 5-pin with wires 60mm
<b>21B</b>	← = Plug system M12, 5-pin with wires 150mm
<b>21C</b>	← = Plug system M12, 5-pin with wires 300mm

DATASHEET - Rev.3 - 18012018

# MAG300

## MAGNETOSTRICTIVE

Measuring length absolute up to 3 m linear position transducer

### TECHNICAL SPECIFICATION

Measuring range	0,1 ... 3 m
Magnetostrictive resolution	0.1 mm
Magnetostrictive Linearity	±0.04 % (F.S)
Magnetostrictive Repeatability	±0.005 % (F.S)
Operating Pressure	350 bars (peak max ... 500 bars)
Type of connection	Plug system M12, 5-pin
Protection	IP67 (provides IP69K environmental protection when installed in a cylinder)
Temperature range	-40°C ... +85°C [-40°F ... +185°F]
Temperature Coefficient	±0.004 % (F.S)/°C
Material	stainless steel AISI316
Rod Diameter	10 mm
Shock resistance	acc. to EN 60068-2-27 30 G, 11 ms
Vibration resistance	acc. to EN 60068-2-6 10 ... 500 Hz

### ELECTRICAL CHARACTERISTICS

Power supply	9 ... 30 V DC
Interface	CANopen
Profile conformity	CIA DS301 (CIA DS406 for SIL2-Pld)
Electromagnetic compatibility	acc. to EN 61326-1, EN 61326-3-1
CE compliant	acc. to EMC guideline 2014/30/EU RoHS guideline 2011/65/EU

### ELECTRICAL CONNECTION M12 X 5 PINS

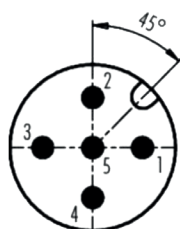

Pinout

1	CAN-GND
2	+Vin
3	GND
4	CAN-H
5	CAN-L

### OPERATING PRINCIPLE

The magnetostrictive effect on metallic wire or rod creates a change in length or volume of the wire or rod in the presence of a magnetic field. Ferromagnetic metals can have negative or positive magnetostrictive properties, for example they can shrink or stretch which in turn decreases or increases its volume. This effect is used in our magnetostrictive linear position sensors.



# MAG300

## MAGNETOSTRICTIVE

Measuring length absolute up to 3 m linear position transducer



### TYPE OF MAGNET

#### 1] Cursor STD

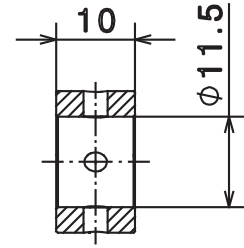
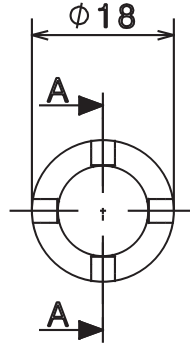
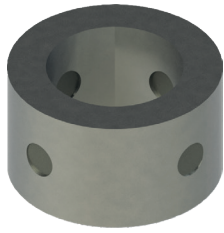

Section A-A



### DIMENSIONS [mm]

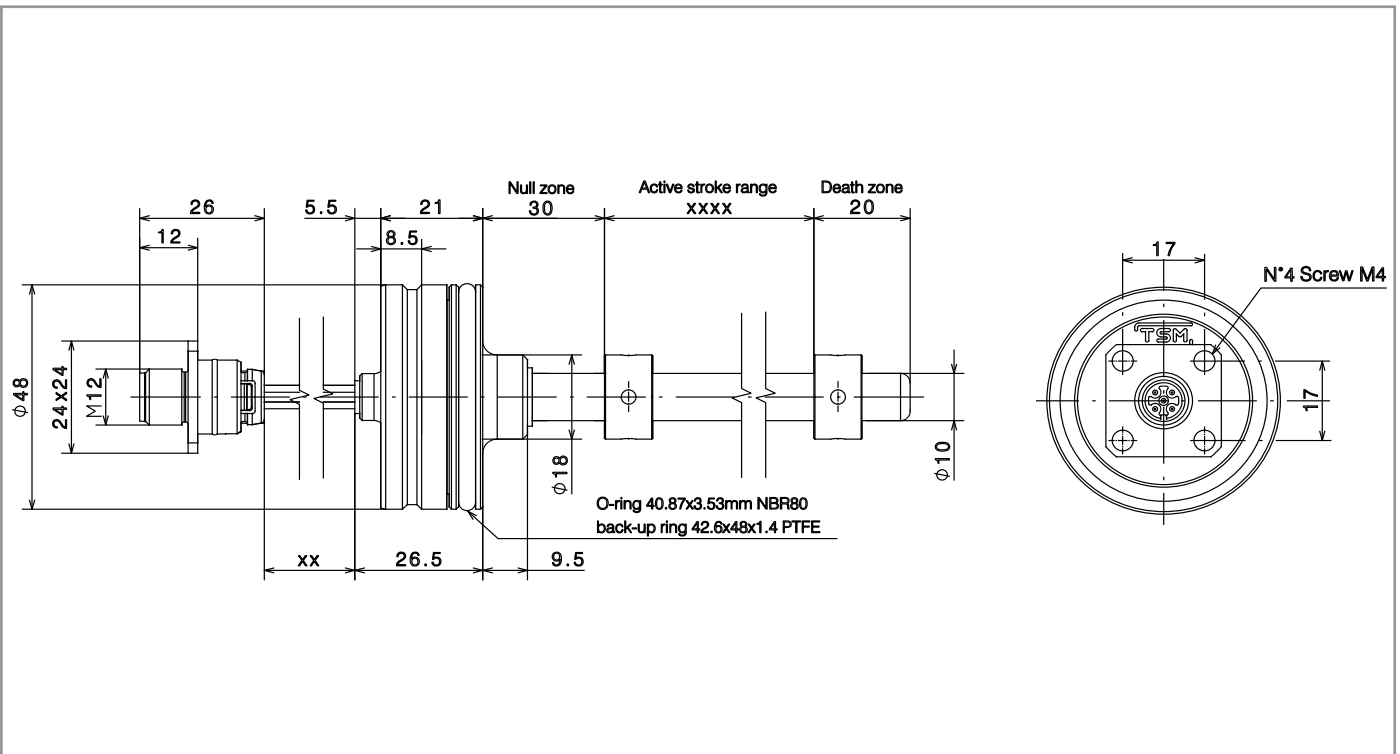

DATASHEET - Rev.3 - 18012018

# MAG300

## MAGNETOSTRICTIVE

Measuring length absolute up to 3 m linear position transducer



### DIMENSIONS [mm]

