

RTB100 CANopen

ROTARY ENCODER

Absolute single turn magnetic encoder without shaft



L.4 - DS0025 R03 RTB100 CANopen 09/01/2026



CHARACTERISTICS

Measuring range 0° to 360°
Redundant sensors
Compact size
Linearity up to $\pm 0.5^\circ$
High protection level and wide temperature range
Anodized aluminum housing



ADVANTAGES

Hall effect technology
Reliability and long service life
Excellent accuracy
Several connections type available
Highly configurable via CANopen
Firmware upgradable via proprietary bootloader



High protection level



Shock/vibration resistant

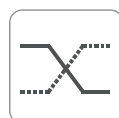

Redundant outputs

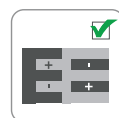

Reverse polarity protection

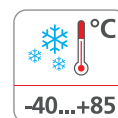

Wide temp. range



CANopen output



CANopen Safety



SAE J1939 output



High accuracy

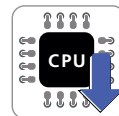

Firmware Upgradable



Directive 2011/65/EU



EU conformity

The company reserves the right to make any kind of design or functional modification at any moment without prior notice.

RTB100 CANopen

ROTARY ENCODER

Absolute single turn magnetic encoder without shaft



PRODUCT DESCRIPTION

RTB100 is a contact-less, magnetic, absolute encoder series featuring high operation speed, intended for harsh environments applications such as high automation and process control.

The contactless technology together with the anodized aluminum housing make this sensor a very robust device with expected life practically infinite thanks to the absence of wear on the sensing element.

Excellent accuracy, high IP rating, shock and vibration resistance and electromagnetic immunity makes this transducer suitable for mobile hydraulic applications such as: agricultural vehicles, earth moving machines, construction equipment, articulated arm cranes and aerial work platforms.



L.4 - DS0025 R03 RTB100 CANopen 09/01/2026



Agricultural machinery



Construction



Earth moving



Handling and lifting

RTB100 CANopen

ROTARY ENCODER

Absolute single turn magnetic encoder without shaft

PRODUCT CODE

ORDER CODE⁽¹⁾ ▶ **RTB100.** **a** **b** **c** **d** **e** **f** **g** **h**

a Counting direction

- 1 ◀ = CH1 & CH2 = CW
- 2 ◀ = CH1 & CH2 = CCW
- 3 ◀ = CH1 = CW, CH2 = CCW
- 4 ◀ = CH1 = CCW, CH2 = CW

b Power supply range

- 2 ◀ = 9 ... 30 V DC
- 6 ◀ = 8 ... 36 V DC

c Measurement range

- 360 ◀ = 360°

d Output type⁽²⁾

- 6 ◀ = CANopen
- 28 ◀ = CANopen with diagnostics
- 40 ◀ = SAE J1939
- 43 ◀ = CANopen safety

e Connections

- 1 ◀ = Male connector M12x5, PUR cable 30cm
- 4 ◀ = Wire connector 5x0.25mm² PUR cable 30cm
- 13 ◀ = Overmolded Deutsch DT04-6P, PUR cable 30cm
- 20 ◀ = Overmolded Deutsch DT04-4P, PUR cable 30cm
- 30 ◀ = Molex Micro-Fit 6 poles (cod. 43025-0600) with PUR cable 30cm
- 31 ◀ = Male connector M8x5 molded 90°, PUR cable 15cm code B
- 39 ◀ = PUR cable 60cm with DT04-6P connector to be assembly⁽³⁾

f Type of magnet

- 1 ◀ = Rotor STD
- 2 ◀ = Screw Magnet "M8, SW13"
- 3 ◀ = Magnet 10 x 2 mm
- 4 ◀ = Screw Magnet "M7, SW11"

g Customization

- X ◀ = None
- ? ◀ = Customization code

h Approvals

- 1 ◀ = Standard components⁽⁴⁾
- 2 ◀ = SIL2/PLd

(1) Not all combinations can be ordered. Please contact TSM for confirmation before placing an order.

(2) Redundant primary measures, acquired by a single logical unit and published on the CANopen output by one or more PDOs, according to the selected mapping.

(3) The cable is supplied with all the connector pins crimped on the wires but with the housing to be mounted separately after installation

(4) Standard component. It does not constitute a safety component as defined in the Machinery Directive 2006/42/CE.

RTB100 CANopen

ROTARY ENCODER

Absolute single turn magnetic encoder without shaft

TECHNICAL SPECIFICATION

Measuring range	0 ... 360°
Resolution	Default: 0.01° Selectable: 0.01° - 0.1° - 1°
Linearity (Ta = 25°C)	±0.5°
Housing	Anodized aluminum
Protection class	IP67 (acc. to EN 60529)
Temperature drift	±0.01 °/°C typ.
Temperature range	-40°C ... +85°C
Weight approx.	60 g
Shock resistance	acc. to EN 60068-2-27 50 G, 11 ms, 100 shocks per axis Axis : X, Y, Z
Vibration resistance	acc. to EN 60068-2-6 10 ... 500 Hz, 10g, 2h per axis Axis : X, Y, Z

ELECTRICAL CHARACTERISTICS

Power supply range	See order code
Consumption typ.	36 mA (12 VDC, w/o load) 18 mA (24 VDC, w/o load)
Startup time	< 1.5 s
Interface	See order code
CANopen profile conformity	CiA DS301
Electromagnetic compatibility	acc. to EN 61326-1, EN 61326-3-1
EU Conformity	EMC directive 2014/30/EU RoHS directive 2011/65/EU + 2015/863/EU

OPERATING PRINCIPLE

Hall effect

Bases its operation principle on the generation of a voltage across an electrical conductor when a magnetic field is applied in a direction perpendicular to the current flow. An hall-effect rotary sensor gives the absolute angular position of a small rotating dipole magnet above the device surface (end of shaft magnet).

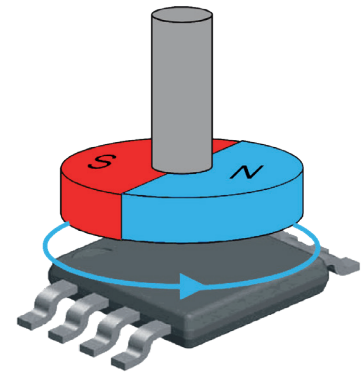

RTB100 CANopen

ROTARY ENCODER

Absolute single turn magnetic encoder without shaft

1) ELECTRICAL CONNECTION M12 X 5 PINS

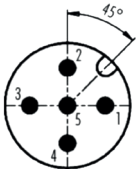

Pinout

1	GND*
2	+Vin
3	CAN-GND*
4	CAN-H
5	CAN-L

* GND and CAN_GND terminals are internally connected to each other and identical in their function

4) ELECTRICAL CONNECTION WIRE CONECTOR

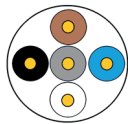

Pinout

Brown	GND*
White	+Vin
Blue	CAN-GND*
Black	CAN-H
Grey	CAN-L

* GND and CAN_GND terminals are internally connected to each other and identical in their function

13 & 39] ELECTRICAL CONNECTION DEUTSCH DT04-6P



	Pinout	Colors
1	GND	Blue
2	+Vin	White
3	n.c.	n.c.
4	n.c.	n.c.
5	CAN-L	Brown
6	CAN-H	Black

20] ELECTRICAL CONNECTION DEUTSCH DT04-4P



Pinout

1	CAN-L
2	CAN-H
3	+Vin
4	GND

31] ELECTRICAL CONNECTION M8 X 5 PINS

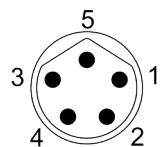

Pinout

	Connector	Accessory
1	CAN-GND*	Brown
2	+Vin	White
3	GND*	Blue
4	CAN H	Black
5	CAN-L	Gray

* GND and CAN_GND terminals are internally connected to each other and identical in their function

30] ELECTRICAL CONNECTION MICROFIT 6 PINS



CONNECTOR SIDE

	Pinout	Colors
1	GND	White
2	+Vin	Blue
3	CAN H	Grey
4	CAN-L	Brown
5	n.c.	Black
6	n.c.	n.c.

RTB100 CANopen

ROTARY ENCODER

Absolute single turn magnetic encoder without shaft



COUNTING DIRECTION (BOTTOM VIEW)

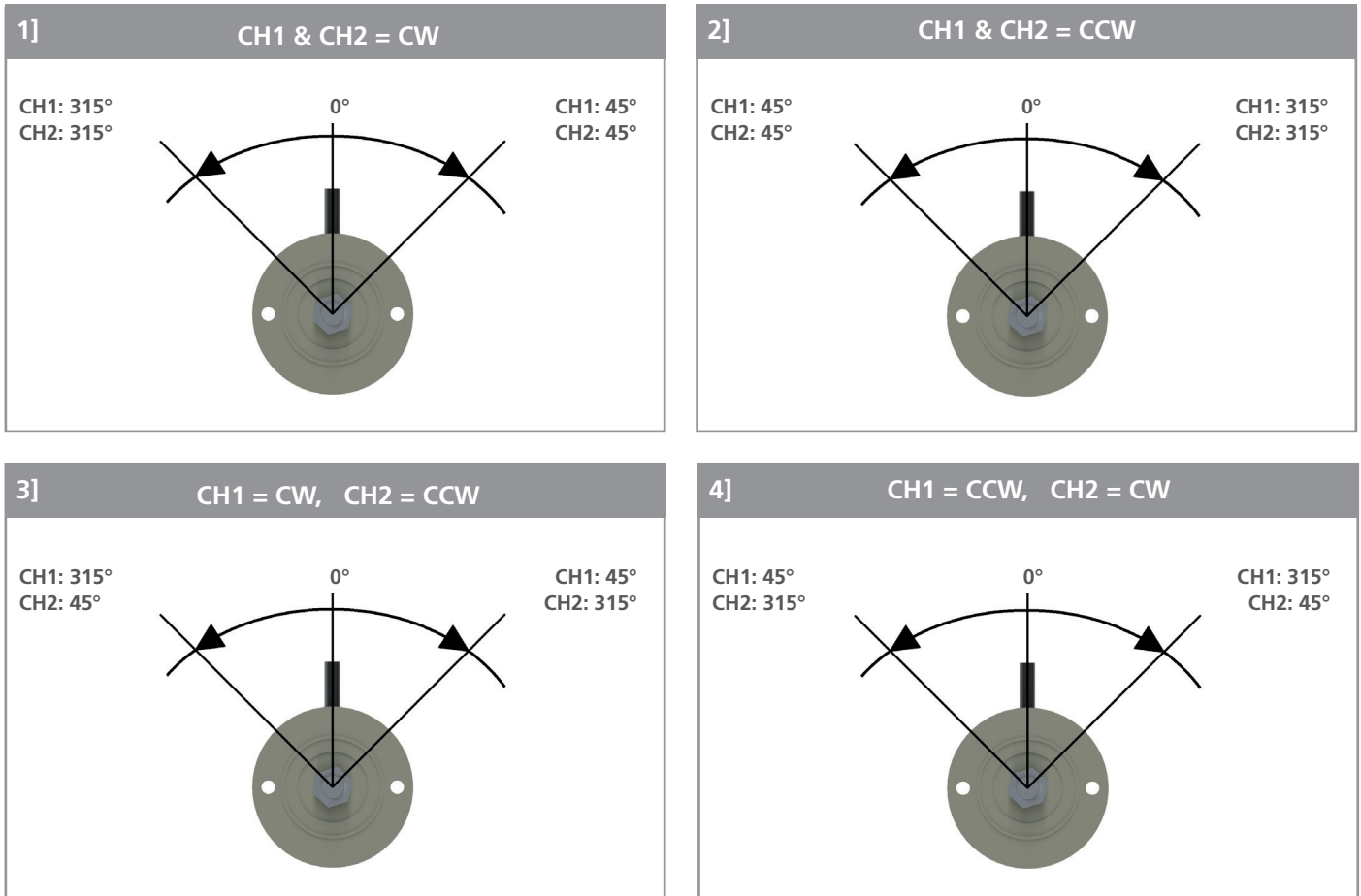

"Zero point is not marked and differs for each unit. It is recommended to set the zero point by sending the related command once the sensor has been installed on the final application"



MAGNET POSITIONING TOLERANCES

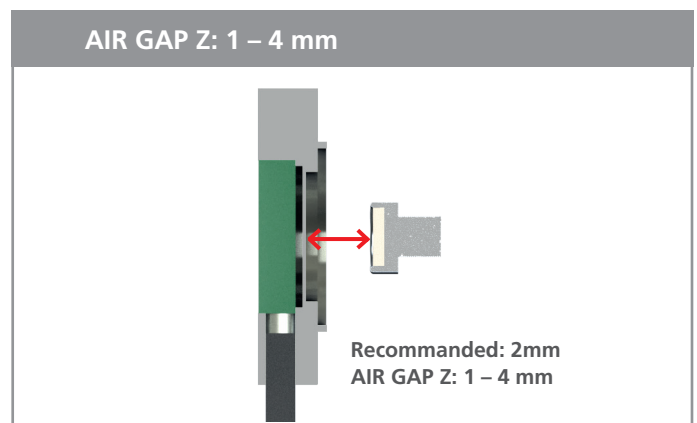

NOTE:

- a) Any extra offset or misalignment increases the non-linearity.
- b) Each sensor **MUST** be mounted with its own rotor / screw / magnet included in the package.
- c) Magnet should **NOT** be incorporated in a ferromagnetic housing (holder)
- d) Magnet must **NOT** be installed in close contact with a surface of ferromagnetic material
- e) The sensor must be mounted using M3 screws in non-magnetic stainless steel e.g. AISI 316

RTB100 CANopen

ROTARY ENCODER

Absolute single turn magnetic encoder without shaft

MAGNETS DIMENSIONS [mm]

1] Rotor STD

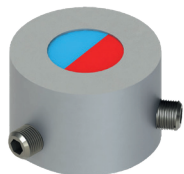

Anodized aluminum

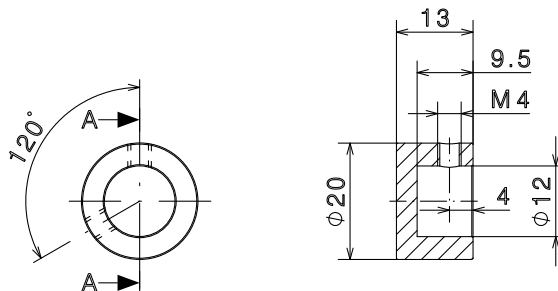

Section A-A
Recommended shaft \varnothing 12 fix threaded x2 pin M4 (included in delivery)

2] Screw magnet "M8, SW13"

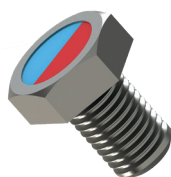

AISI316L

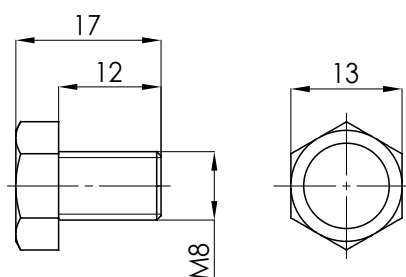

3] Magnet 10 x 2 mm

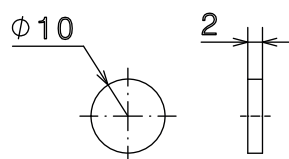

4] Screw magnet "M7, SW11"

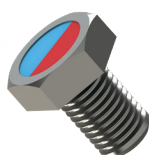

AISI316L

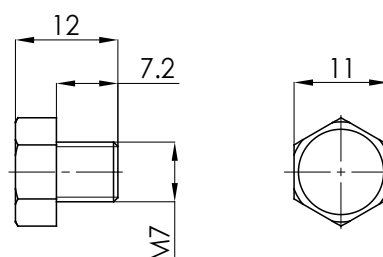

RTB100 CANopen

ROTARY ENCODER

Absolute single turn magnetic encoder without shaft



DIMENSIONS [mm]

