

TLA200 Analog

INCLINOMETER

MEMS technology tilt sensor



L.4 - DS0034 R01 TLA200 Analog



CHARACTERISTICS

- MEMS technology
- High protection level and wide temperature range
- High temperature stability
- Resolution up to 0.01°
- Single axis range $\pm 180^\circ$ or 0 ... 360°
- Dual axis range up to $\pm 60^\circ$



ADVANTAGES

- Gyro-compensated
- Excellent accuracy
- Reliability and long service life for outdoor applications
- Compact dimensions
- Designed for harsh environmental conditions



High protection level



Shock/vibration resistant



Reverse polarity protection



Wide temp. range



Analog output



MEMS sensors technology

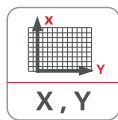

Horizontal version

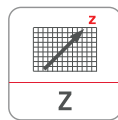

Vertical version



High accuracy

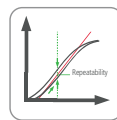

High repeatability



Directive 2011/65/EU



EU conformity

The company reserves the right to make any kind of design or functional modification at any moment without prior notice.

TLA200 Analog

INCLINOMETER

MEMS technology tilt sensor



PRODUCT DESCRIPTION

An inclinometer measures the angle to the direction of the gravity in one or more axes.

TLA200 is the new family of inclination sensors, based on the MEMS technology, capable of working in extreme conditions and hard environments, subjected to sharp movements, shocks and high vibrations.

The perfect synthesis of precision, stability, robustness and cost, which make it suitable for use on mobile devices and applications such as: cranes, aerial platforms, operating and earth moving machines.

The integration of accelerometers and gyroscopes with sensor fusion proprietary algorithms, ensure high performances over all the operating range.



L.4 - DS0034 R01 TLA200 Analog



Agricultural machinery



Construction



Earth moving



Handling and lifting

TLA200 Analog

INCLINOMETER

MEMS technology tilt sensor



PRODUCT CODE

ORDER CODE⁽¹⁾ ▶ TLA200. a . b . c . d . e . f . g . h

- a** Power supply range
 - 2** ◀ = 9 ... 30 V DC (only for outputs 2; 3)
 - 3** ◀ = 12 ... 30 V DC (only for outputs 4; 7; 5)
- b** Axis type
 - O** ◀ = Dual axis (floor mounting)
 - V** ◀ = Single axis - unipolar (wall mounting)
 - V1** ◀ = Single axis - bipolar (wall mounting)
- c** Measurement range
 - XXX** ◀ = 0 ... XXX deg (for axis type V)
 - XXX** ◀ = ± XXX deg (for axis type O and V1)
- d** Output type
 - 2** ◀ = 0,5 ... 4,5 V DC
 - 3** ◀ = 0 ... 5 V DC
 - 5** ◀ = 1 ... 7 V DC
 - 4** ◀ = 0 ... 10 V DC
 - 7** ◀ = 4 ... 20 mA
- e** Connections
 - 1** ◀ = Male connector M12, 5-pin PUR cable 30cm
 - 2** ◀ = Male flange connector M12, 5-pin
- f** Architecture⁽²⁾
 - S** ◀ = Single tilt sensor
 - R** ◀ = Redundant tilt sensors
- g** Options
 - 0** ◀ = Static (without gyro-compensation function)
 - 1** ◀ = Dynamic (with gyro-compensation function)
- h** Customization
 - X** ◀ = None
 - ?** ◀ = Customization code

L.4 - DS0034 R01 TLA200 Analog

(1) Not all combinations can be ordered. Please contact TSM for confirmation before placing an order.
 (2) Redundant architecture is available only for V e V1 axis type.

TLA200 Analog

INCLINOMETER

MEMS technology tilt sensor



TECHNICAL SPECIFICATION

Measuring range	Up to $\pm 60^\circ$ for dual axis type $\pm 180^\circ$ and 0 ... 360° for single axis type
Accuracy (Ta = 25 °C)	$\pm 0.3^\circ$
Resolution	0.01°
Temperature drift	± 0.01 °/°C typ.
Protection class	IP68 (acc. to EN 60529)
Temperature range	-40°C ... +85°C
Housing	Anodized aluminum
Weight approx.	360 g
Shock resistance	acc. to EN 60068-2-27 50 G, 11 ms, 100 shocks per axis Axis : X, Y, Z
Vibration resistance	acc. to EN 60068-2-6 10 ... 500 Hz, 10g, 2h per axis Axis : X, Y, Z

ELECTRICAL CHARACTERISTICS

Power supply range	See order code
Consumption typ. (with load at FS)	<u>Current output:</u> Single: 36 mA (12 VDC); 35 mA (24 VDC) Redundant: 56 mA (12 VDC); 50 mA (24 VDC) <u>Voltage output:</u> Single: 19 mA (12 VDC); 18 mA (24 VDC) Redundant: 20 mA (12 VDC); 19 mA (24 VDC)
Startup time	< 300ms
Load resistor	> 10 kOhm, voltage output type < 500 Ohm, current output type
Electromagnetic compatibility	acc. to EN 61000-6-2, EN 61000-6-4
EU Conformity	EMC directive 2014/30/EU RoHS directive 2011/65/EU + 2015/863/EU

OPERATING PRINCIPLE

MEMS, or Micro Electro-Mechanical System, is a chip-based technology where sensors are composed of proof masses sprung between capacitive plates. Each mass act like a moving plate of a variable capacitor formed by an array of interlaced 'fingers'.

When the sensor is tilted, the mass moves changing the distance between the plates and therefore the capacitance. By measuring the capacitance variation the angle value can be detected.

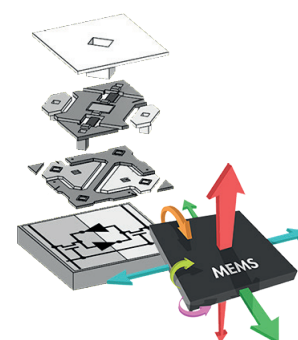

L.4 - DS0034 R01 TLA200 Analog

ELECTRICAL CONNECTION M12 X 5 PINS

Pinout

	Single axis	Dual axis
1	+Vin	+Vin
2	V / I out Z 2*	V / I out Y
3	GND	GND
4	V / I out Z 1	V / I out X
5	zero input**	zero input**

The device is protected against reverse polarity of power supply (Pin 1 and 3). No protection to incorrect connection of all the other pins. Applying a voltage to pin 2, 4 and 5, can damage the device!
 * = Only for redundant versions with axis type V and V1. In all other cases leave unconnected.
 ** = Connect to GND for 2s to set zero point

ANALOG OUTPUTS

Single axis

Dual axis

$V = 0 \dots 360^\circ$

$V1 = \pm 180^\circ$

$O = \pm 60^\circ$

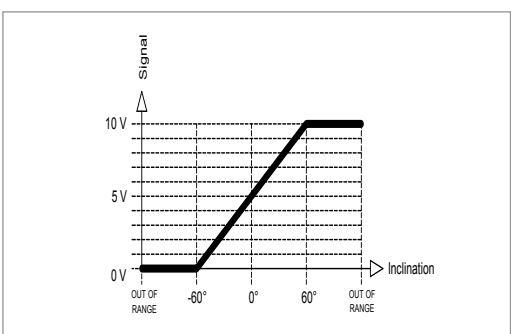
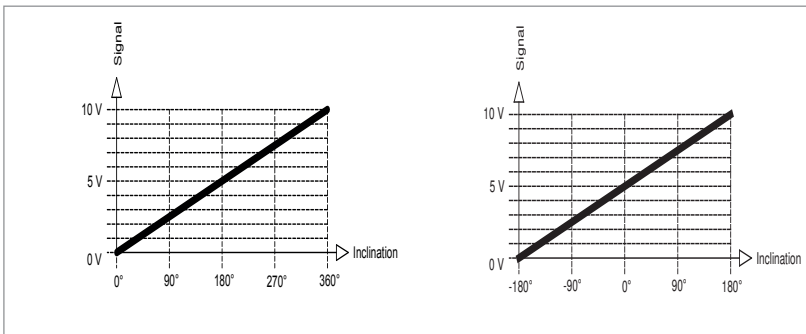
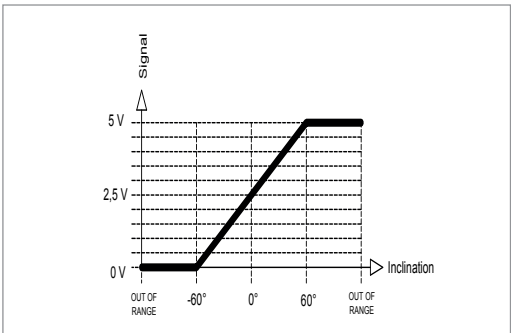
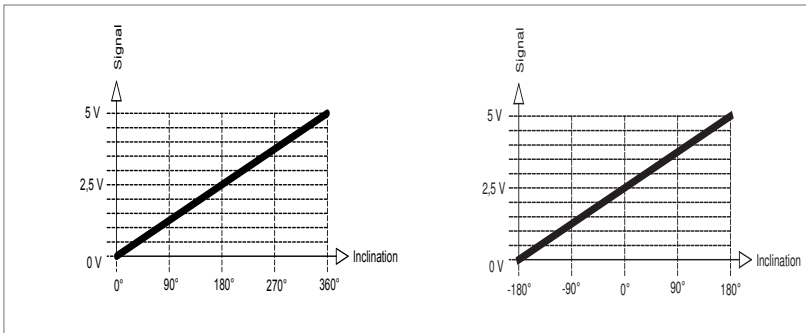
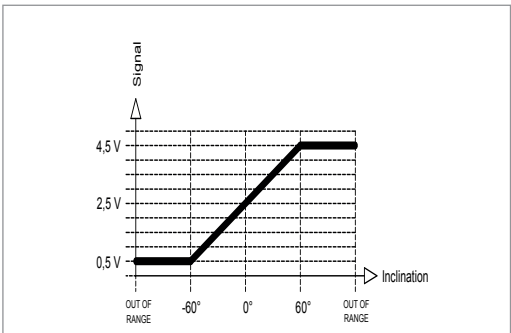
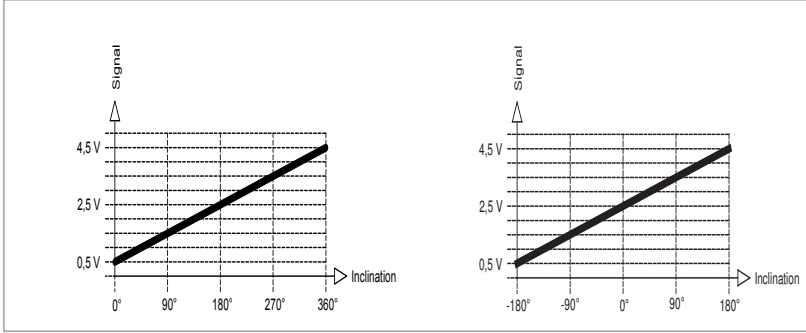
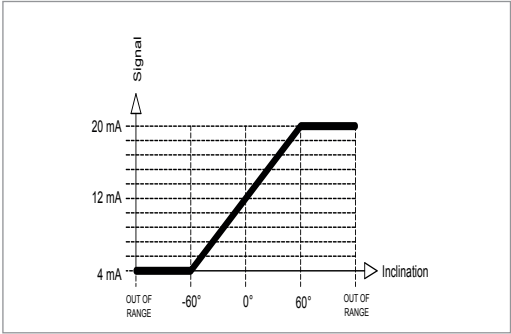
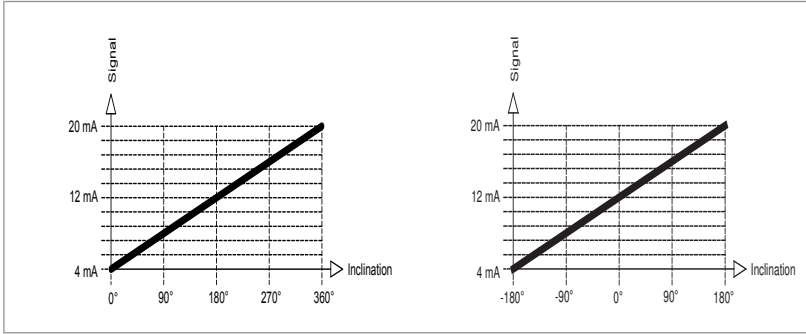

L.4 - DS0034 R01 TLA200 Analog



COUNTING DIRECTION

Dual axis

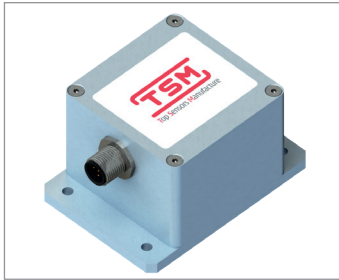

TLA200 dual axis inclinometer

The 2-dimensional tilt sensor must be mounted with the base plate in horizontal position, i.e. parallel to the horizontal line. The sensor can be tilted to both the X and Y axes at the same time. A separate measure is provided for each axis.

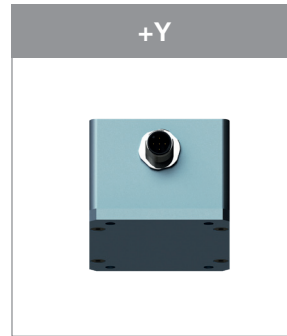
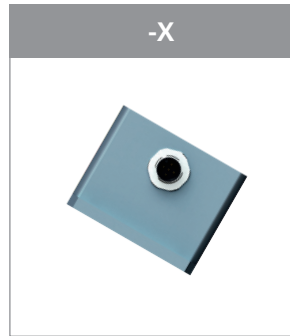
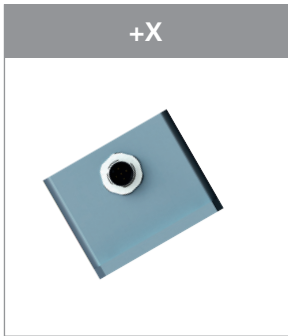

Single axis



TLA200 single axis inclinometer

The 1-dimensional tilt sensor must be installed with the base plate in vertical position, i.e. Z-axis perpendicular to the force of gravity.

The default "zero point" position is the one shown in the following images.

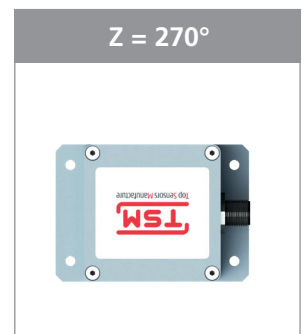
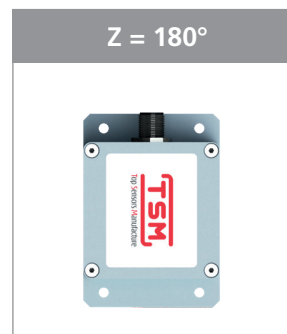
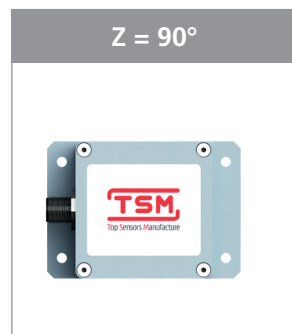

TLA200 Analog

INCLINOMETER

MEMS technology tilt sensor



DIMENSIONS [mm]

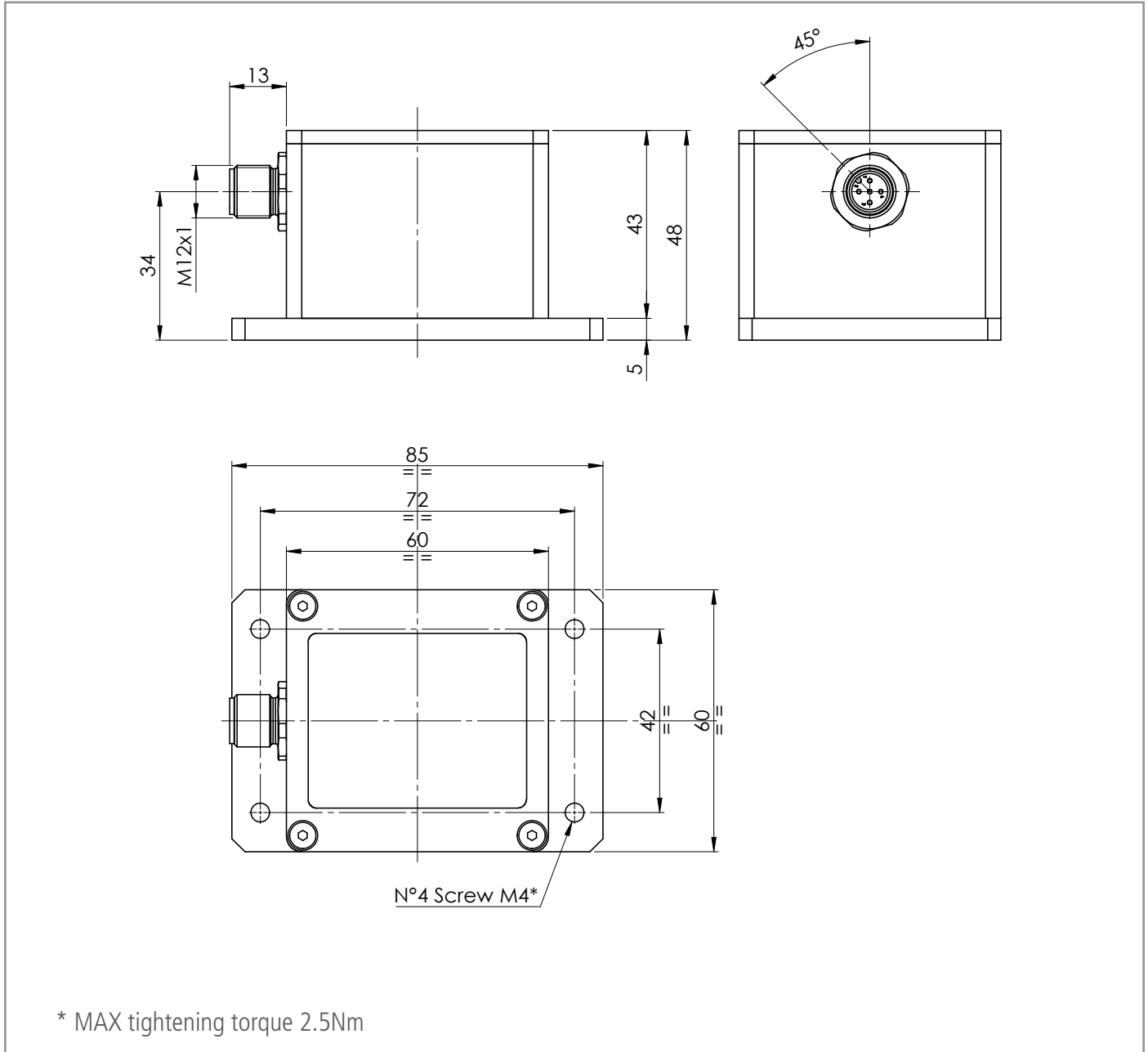

L.4 - DS0034 R01 TLA200 Analog

* MAX tightening torque 2.5Nm