

TLP300 CANopen

INCLINOMETER

MEMS technology tilt sensor



L.4 - DS0026 R14 TLP300 CANopen 10/04/2026



CHARACTERISTICS

MEMS technology
High protection level and wide temperature range
High temperature stability
Resolution up to 0.01°
Single axis range $\pm 180^\circ$ or 0 ... 360°
Dual axis range up to $\pm 85^\circ$



ADVANTAGES

Gyro-compensated
Excellent accuracy
Reliability and long service life for outdoor applications
Compact dimensions
Designed for harsh environmental conditions



High protection level



Shock/vibration resistant

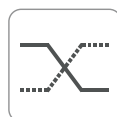

Redundancy output

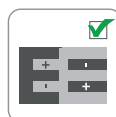

Reverse polarity protection

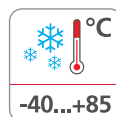

Wide temp. range



CANopen output



CANopen Safety



MEMS sensors technology

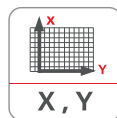

Horizontal version

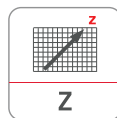

Vertical version



High accuracy

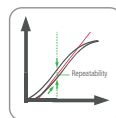

High repeatability



Directive 2011/65/EU



EU conformity

The company reserves the right to make any kind of design or functional modification at any moment without prior notice.

TLP300 CANopen

INCLINOMETER

MEMS technology tilt sensor



PRODUCT DESCRIPTION

An inclinometer measures the angle to the direction of the gravity in one or more axes.

TLP300 is the new family of inclination sensors, based on the MEMS technology, capable of working in extreme conditions and hard environments, subjected to sharp movements, shocks and high vibrations.

The perfect synthesis of precision, stability, robustness and cost, which make it suitable for use on mobile devices and applications such as: cranes, aerial platforms, operating and earth moving machines.

The integration of accelerometers and gyroscopes with sensor fusion proprietary algorithms, ensure high performances over all the operating range.



Agricultural machinery



Construction



Earth moving



Handling and lifting

L.4 - DS0026 R14 TLP300 CANopen 10/04/2026

TLP300 CANopen

INCLINOMETER

MEMS technology tilt sensor



PRODUCT CODE

ORDER CODE⁽¹⁾ ▶ TLP300. **a** **b** **c** **d** **e** **f** **g** **h** **i**

a Power supply range
2 ◀ = 9 ... 30 V DC
6 ◀ = 8 ... 36 V DC

b Axis type
O ◀ = Dual axis (floor mounting)
V ◀ = Single axis (wall mounting)

c Measurement range
360 ◀ = 0 ... 360 deg
XXX ◀ = ± XXX deg

d Output type
6 ◀ = CANopen
28 ◀ = CANopen with diagnostics
43 ◀ = CANopen safety

e Connections
1 ◀ = Male connector M12, 5-pin PUR cable 30cm
2 ◀ = Male flange connector M12, 5-pin
20 ◀ = Overmolded Deutsch DT04-4P, PUR cable 30cm
62 ◀ = Overmolded Deutsch DT04-4P, PUR cable 30cm pinout type A

f Architecture⁽²⁾
S ◀ = Single tilt sensor
R ◀ = Redundant tilt sensors

g Options
0 ◀ = Static (without gyro-compensation function)
1 ◀ = Dynamic (with gyro-compensation function)

h Customization
X ◀ = None
? ◀ = Customization code

i Approvals
1 ◀ = Standard components⁽³⁾
2 ◀ = SIL2/PLD

(1) Not all combinations can be ordered. Please contact TSM for confirmation before placing an order.

(2) Redundant primary measures, acquired by a single logical unit and published on the CANOpen output by one or more PDOs, according to the selected mapping.

(3) Standard component. It does not constitute a safety component as defined in the Machinery Directive 2006/42/CE.

TLP300 CANopen

INCLINOMETER

MEMS technology tilt sensor



TECHNICAL SPECIFICATION

Measuring range	Up to $\pm 85^\circ$ for dual axis type $\pm 180^\circ$ and 0 ... 360° for single axis type
Static accuracy (Ta = 25 °C)	$\pm 0.3^\circ$
Resolution	0.01°
Temperature drift (at 0° inclination)	± 0.01 °/°C typ. (**)
Protection class	IP68 (acc. to EN 60529)
Temperature range	-40°C ... +85°C
Housing	Glass fiber reinforced polyamide
Weight approx.	70 g
Shock resistance	acc. to EN 60068-2-27 50 G, 11 ms, 100 shocks per axis Axis : X, Y, Z
Vibration resistance	acc. to EN 60068-2-6 10 ... 500 Hz, 10g, 2h per axis Axis : X, Y, Z
Corrosion resistance	Salt spray tests acc. to EN ISO 9227 / ISO 12944-6

ELECTRICAL CHARACTERISTICS

Power supply range	See order code
Consumption typ.	30 mA (12 VDC, w/o load) 15 mA (24 VDC, w/o load)
Startup time	< 1.5 s
Interface	CANopen CANopen safety
CANopen profile conformity	CiA 301
EMC compatibility (Industrial electromagnetic environment)	acc. to EN 61326-1, EN 61326-3-1 acc. to ISO 19014-3:2018 (test method ISO 13766-1, ISO13766-2)
Conducted electrical transients immunity (*):	Surge test acc. to ISO7637-2 pulse 1, 2a, 2b, 3a, 3b Momentary drop in supply voltage acc. to ISO 16750-2 §4.6.1 Reset behaviour at voltage drop acc. to ISO 16750-2 §4.6.2 Starting profile acc. to ISO 16750-2 §4.6.3 Load dump acc. ISO 16750-2 §4.6.4 Test A
EU conformity	EMC directive 2014/30/EU UNECE Reg. 10 R06 (*) RoHS directive 2011/65/EU + 2015/863/EU

OPERATING PRINCIPLE

MEMS, or Micro Electro-Mechanical System, is a chip-based technology where sensors are composed of proof masses sprung between capacitive plates. Each mass act like a moving plate of a variable capacitor formed by an array of interlaced 'fingers'.

When the sensor is tilted, the mass moves changing the distance between the plates and therefore the capacitance. By measuring the capacitance variation the angle value can be detected.

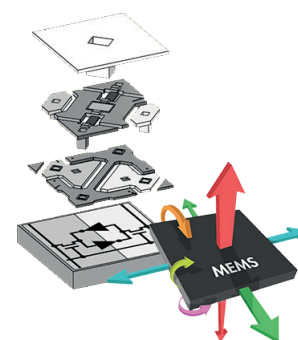

L.4 - D50026 R14 TLP300 CANopen 10/04/2026

(*) Valid only for 8 ... 36 V DC version

(**) Drift < ± 0.01 °/°C for temperature compensated versions (Options .2 and .3) in the range -20°C ... +60°C

TLP300 CANopen

INCLINOMETER

MEMS technology tilt sensor



1 & 2] ELECTRICAL CONNECTION M12 X 5 PINS

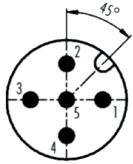

Pinout

1	CAN-GND*
2	+Vin
3	GND*
4	CAN-H
5	CAN-L

* GND and CAN_GND terminals are internally connected to each other and identical in their function

20] ELECTRICAL CONNECTION DEUTSCH DT04-4P



Pinout

1	CAN-L
2	CAN-H
3	+Vin
4	GND

62] ELECTRICAL CONNECTION DEUTSCH DT04-4P pinout type A



Pinout

1	+Vin
2	GND
3	CAN-L
4	CAN-H

L4 - DS0026 R14 TLP300 CANopen 10/04/2026

TLP300 CANopen

INCLINOMETER

MEMS technology tilt sensor



COUNTING DIRECTION

Dual axis



TLP300 dual axis inclinometer

The 2-dimensional tilt sensor must be mounted with the base plate in horizontal position, i.e. parallel to the horizontal line. The sensor can be tilted to both the X and Y axes at the same time. A separate measure is provided for each axis.

+X



-X



+Y



-Y



Single axis



TLP300 single axis inclinometer

The 1-dimensional tilt sensor must be installed with the base plate in vertical position, i.e. Z-axis perpendicular to the force of gravity.

The default "zero point" position is the one shown in the following images.

Z = 0°



Z = 90°



Z = 180°



Z = 270°



TLP300 CANopen

INCLINOMETER

MEMS technology tilt sensor



DIMENSIONS [mm]

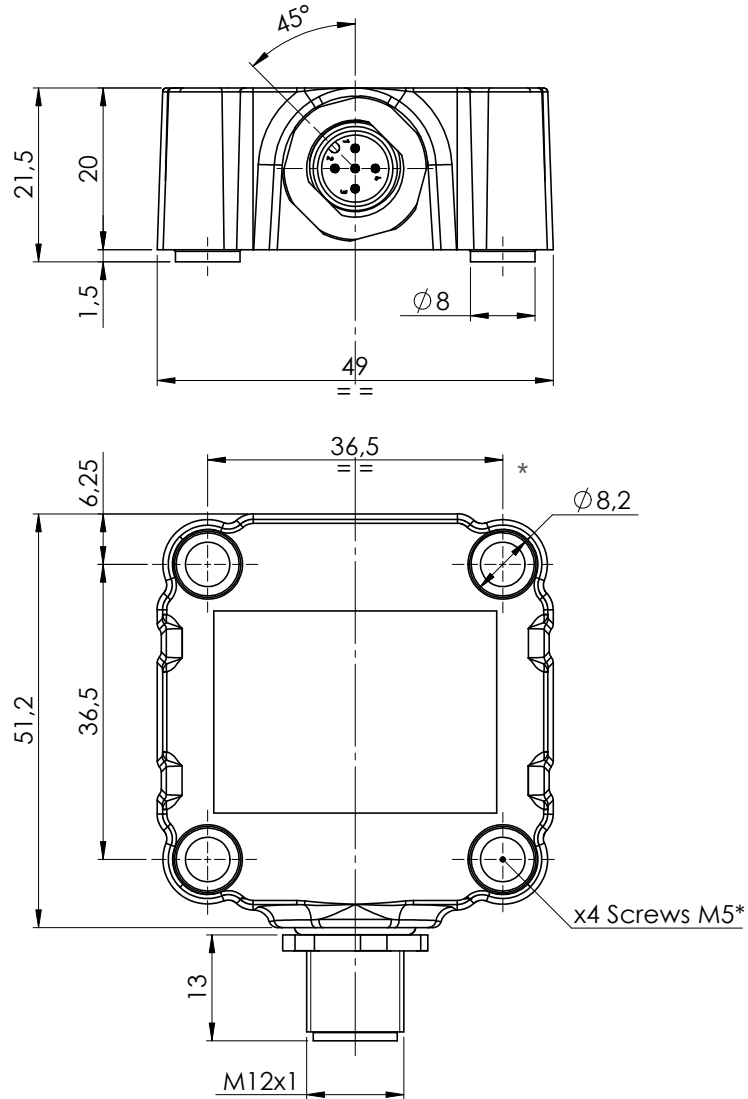

* MAX tightening torque 2Nm